

High quality compression driver with dome diaphragm in pure titanium, offers high efficiency and low distortion over the medium and high frequencies band.

It can be successfully used in studio monitors, stage boxes and sound reinforcement in small rooms, where a high performance is requested.

This performance results from the proper combination of the components.

Diaphragm type dome in pure, rigid, light and extremely thin titanium (0.025 mm). To avoid stress and distortion, the suspension has a special design.

Injected phase plug in engineering plastic, optimized to eliminate undesirable phase cancellations.

Magnetic assembly that concentrates flux in the gap, optimized using FEA (Finite Element Analysis).

Voice coil manufactured in CCAW (Copper Clad Aluminium Wire), Kapton® former, assures great stability and thermal resistance.

The moving assembly has a perfect auto-centering characteristic that turns replacement in an easy task.

Model D202Ti uses standard 1 3/8" screw - 18 threads per inches, for better fitting with Selenium horns.



OBS.: In order to change the repair easily, ANY KIND OF CONNECTION THAT YOU WISH TO USE SHOULDN'T WELDED AT D200 TERMINAL'S DRIVER. This will cause the loose of the product's warranty. Selenium engineers suggest to use the faston connectors supplied.

### SPECIFICATIONS

Nominal impedance . . . . . 8 Ω  
Minimum impedance @ 4,280 Hz . . . . . 6.7 Ω

POWER USING CROSSOVER	ACTIVE	PASSIVE
AES (HPF 1,5KHz - 12dB/oct) <sup>4</sup> . . . . .	16	40 W
AES (HPF 2,0KHz - 12dB/oct) <sup>4</sup> . . . . .	24	60 W
MUSICAL PROGRAM (HPF 1,5KHz - 12dB/oct) <sup>1</sup> . . . . .	32	80 W
MUSICAL PROGRAM (HPF 2,0KHz - 12dB/oct) <sup>1</sup> . . . . .	48	120 W

Sensitivity  
On horn, 2.83V@1m, on axis<sup>2</sup> . . . . . 106 dB SPL  
On plane-wave tube, 0.0894V<sup>3</sup> . . . . . 111 dB SPL  
Frequency response @ -6 dB . . . . . 1,000 to 20,000 Hz  
Throat diameter . . . . . 25 (1) mm (in)  
Diaphragm material . . . . . Titanium  
Voice coil diameter . . . . . 44 (1.7) mm (in)  
Re . . . . . 6.0 Ω  
Flux density . . . . . 1.01 T  
Minimum recommended crossover (12 dB / oct) . . . . . 1,500 Hz

<sup>1</sup> Power handling specifications refer to normal speech and/or music program material, reproduced by an amplifier producing no more than 5% distortion. Power is calculated as true RMS voltage squared divided by the nominal impedance of the loudspeaker. This voltage is measured at the input of the recommended passive crossover when placed between the power amplifier and loudspeaker.

<sup>2</sup> Measured with HL14-25 horn, 1,200 - 15,000 Hz average.

<sup>3</sup> The sensitivity represents the SPL in a 25 mm terminated tube, 800 - 2,000 Hz average.

<sup>4</sup> Test with duration of 2h with pink noise (from 6dB crest factor) and filtered a decade of often-cut.

### ADDITIONAL INFORMATION

Magnet material . . . . . Barium ferrite  
Magnet weight . . . . . 210 (7.5) g (oz)  
Magnet diameter x depth . . . . . 90 x 10 (3.53 x 0.26) mm (in)  
Magnetic assembly weight . . . . . 850 (1.87) g (lb)  
Housing material . . . . . Plastic  
Housing finish . . . . . Black  
Voice coil material . . . . . CCAW  
Voice coil former material . . . . . Polyimide (Kapton®)  
Voice coil winding length . . . . . 2.6 (8.25) m (ft)  
Voice coil winding depth . . . . . 2.7 (0.108) mm (in)  
Wire temperature coefficient of resistance (α25) . . . . . 0.00435 1/°C  
Volume displaced by driver . . . . . 0.3 (0.0108) l (ft<sup>3</sup>)  
Net weight . . . . . 890 (1.96) g (lb)  
Gross weight . . . . . 925 (2.04) g (lb)  
Carton dimensions (W x D x H) . . . . . 9.5 x 9.5 x 7 (3.7 x 3.7 x 2.7) cm (in)

### MOUNTING INFORMATION

Horn connection . . . . . Screw-on 1 3/8" - 18 TPI  
Connectors . . . . . Terminals  
Polarity . . . . . Positive voltage applied to the positive terminal (red) gives diaphragm motion toward the throat

### CONNECTION DRIVER x HORN

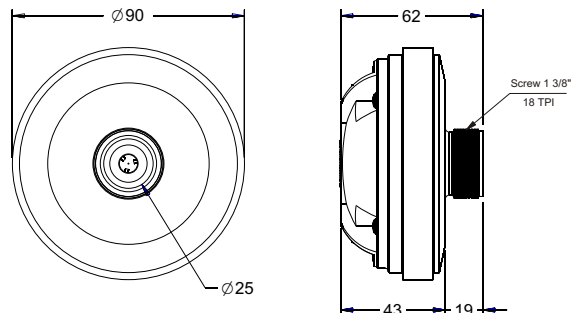
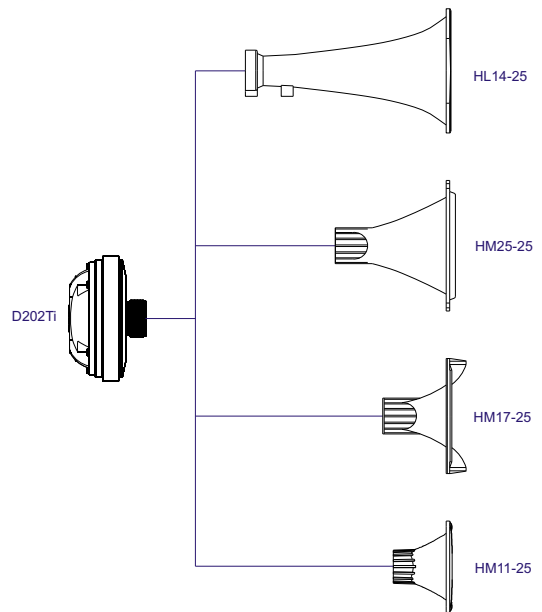

Design illustration

Dimensions in mm.

**RESPONSE AND IMPEDANCE CURVES W/ HL14-25 HORN INSIDE AN ANECHOIC CHAMBER, 1 W / 1 m**

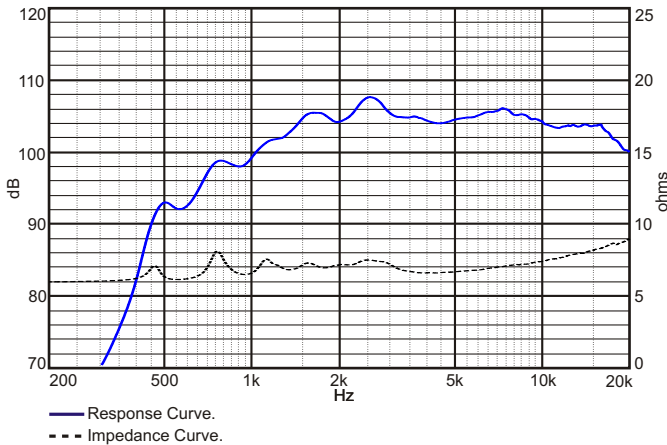

**HARMONIC DISTORTION CURVES W/ HL14-25 HORN, 5 W / 1 m.**

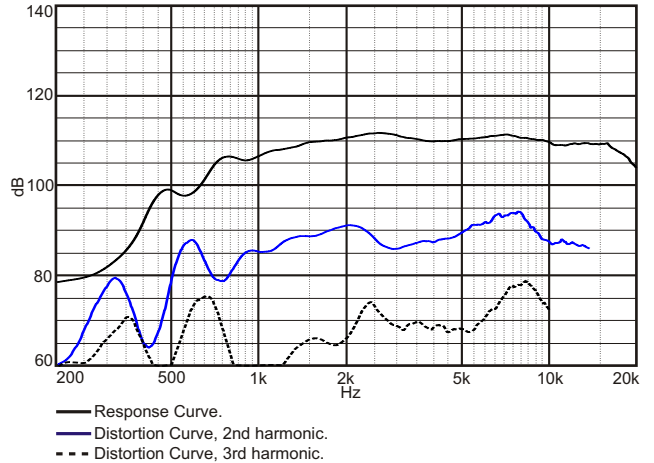

**RESPONSE AND IMPEDANCE CURVES W/ PLANE-WAVE TUBE, 1 mW**

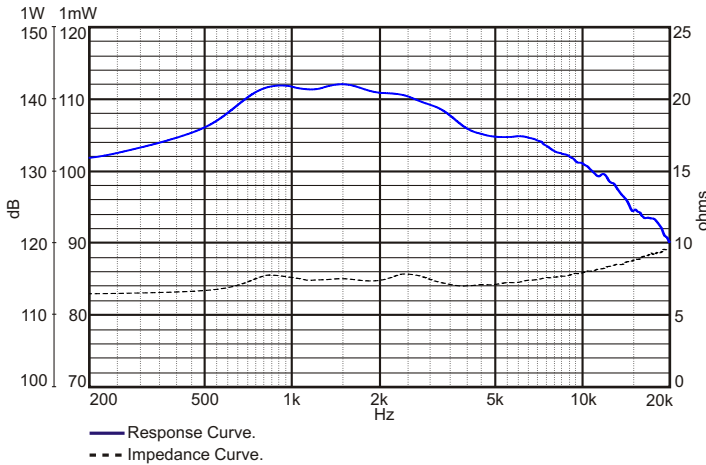

Frequency response and impedance curves measured with 25 mm terminated plane-wave tube.

**POLAR RESPONSE CURVES**

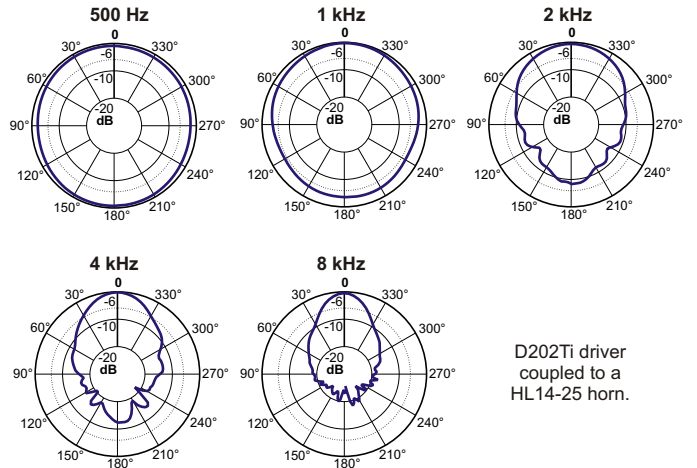

D202Ti driver coupled to a HL14-25 horn.

— Polar Response Curve.

**HARMONIC DISTORTION CURVES W/ HL14-25 HORN, 1 W / 1 m.**

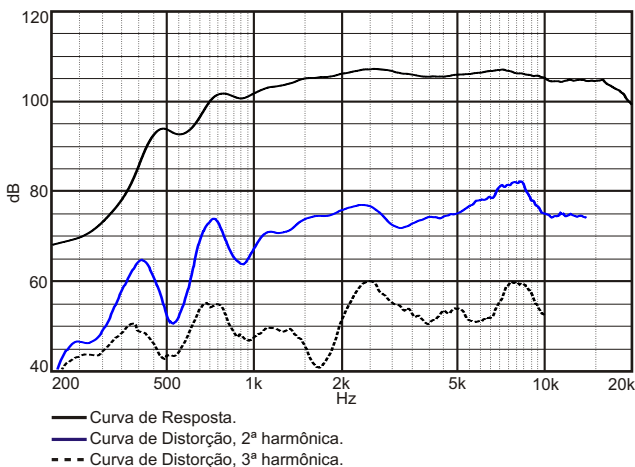

**HOW TO CHOOSE THE RIGHT AMPLIFIER**

The power amplifier must be able to supply twice the RMS driver power. This 3 dB headroom is necessary to handle the peaks that are common to musical programs. When the amplifier clips those peaks, high distortion arises and this may damage the transducer due to excessive heat. The use of compressors is a good practice to reduce music dynamics to safe levels.

**FINDING VOICE COIL TEMPERATURE**

It is very important to avoid maximum voice coil temperature. Since moving coil resistance ( $R_e$ ) varies with temperature according to a well known law, we can calculate the temperature inside the voice coil by measuring the voice coil DC resistance:

$$T_B = T_A + \left( \frac{R_B}{R_A} - 1 \right) \left( T_A - 25 + \frac{1}{\alpha_{25}} \right)$$

$T_A, T_B$  = voice coil temperatures in °C.

$R_A, R_B$  = voice coil resistances at temperatures  $T_A$  and  $T_B$ , respectively.

$\alpha_{25}$  = voice coil wire temperature coefficient at 25 °C.